

REMOTE PON NETWORK PERFORMANCE

Edward Boyd
Tibit Communications

Kevin A. Noll
Time Warner Cable

Saifur Rahman & Nagesh Nandiraju
Comcast Cable

Fernando Villarruel
Cisco Systems

Abstract

Ethernet Passive Optical Network (EPON) systems have been successfully deployed worldwide for high-speed access networks and are enjoying a growing adoption by cable operators.

However, MSO access networks have challenges beyond the capabilities of traditional PON solutions. First, many operators have fewer trunk fibers to the node available for PON than required for a large number of subscribers. Second, Cable operators often find that their current access networks reach farther than the distances supported by traditional PON solutions. Greenfield deployments offer little relief because they are sometimes located far from the operator's existing head end or hub sites.

In an attempt to simplify maintenance, reduce operational costs, and improve reliability, many operators prefer a centralized network deployment model which reduces the number of head ends and hub sites and aggregates many customers over a large service area. Collapsing the head ends and hub sites in favor of a more centralized model naturally leads to longer distances between the network aggregation systems and the customers. This escalates the difficulties related to reaching those customers using traditional PON architectures.

Operators need a way to support a longer reach network that uses existing PON standards, technology, and systems. One approach to this problem can be gleaned from the network topology used in HFC architectures in use today. A remote NODE can provide an enclosure for an active PON device to extend the reach, minimize the fibers required to serve subscribers, and allow for large centralized systems.

This paper compares and contrasts several solutions for implementing a PON in a NODE-based architecture. The solutions examined here will include a simple PON extender, a remote optical line terminal (OLT), and a distributed PON MAC/PHY solution. Each solution is examined for its impact on trunk fiber efficiency, equipment cost, power, subscriber count, physical space, PON efficiency, physical layer performance, packet jitter, and packet delay. The operator requirements for the remote PON network are discussed to highlight the differences between these solutions and their impacts to the service opportunities.

THE REMOTE PON NETWORK

What is a remote PON network?

Ideally, PON Networks are fully passive without any active electronics in the outside plant with an OLT located in Headend or Hub Site. These Local PON networks can be serviced by large commercial OLT shelves in environmentally controlled offices.

Adding more headends or hub-sites to service FTTP deployments beyond the reach of the Local PON network is not cost effective. Additionally, air conditioned cabinets in the outside plant are expensive to build and maintain. While higher power optics can be used to increase the split ratio or the distance of a PON networks, these devices are not common and are therefore more expensive. Longer Reach optics are also more difficult or impractical for higher speed PON like 10Gbps

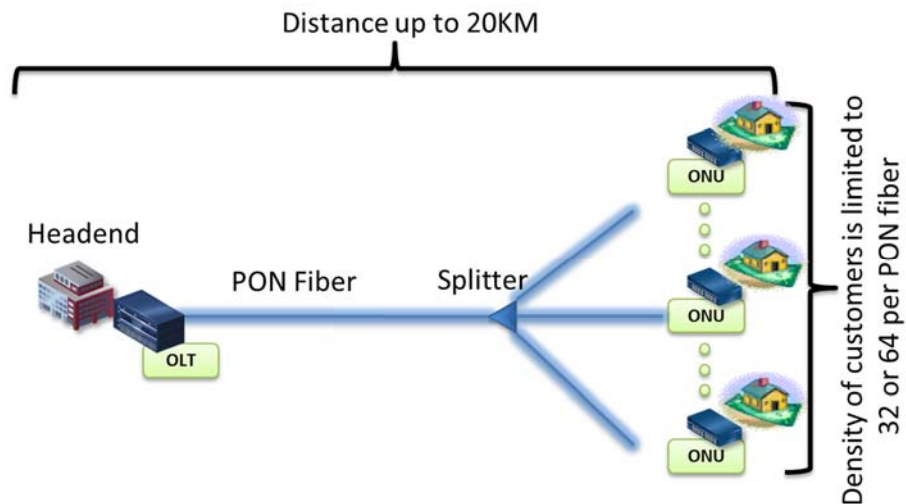

Figure 1: Local PON Network Limitations

Remote PON Networks cannot be serviced passively from an OLT in the Headend or Hub site. Remote PON Networks are required when the distance from the headend or hub site exceeds the PON specification or the density of customers requires more trunk fibers than available in the MSO network. Adding large numbers of trunk fiber can be prohibitively expensive for the operator. PON Systems have been designed for 1 to 32 or 1 to 64 split ratios at 20 kilometers using a fixed set of wavelengths. Since MSO networks have traditionally serviced longer loops and higher densities, the need for a remote PON is very common. For example, a high density MDU with fiber to the apartment would require many fibers to the MDU. A Remote PON originating at the MDU could have a higher split ratio and minimize the fiber required by the MSO.

or future speeds beyond 10Gbps.

A Remote PON Termination Device (RPTD) is needed to connect the Remote PON with the trunk network to the headend. The ideal Remote PON termination Device is hardened for the outside plant, small enough to fit in an amplifier or node housing, and uses the same standard PON optics for the Remote PON network as the Local PON networks. PON or WDM can be used on the trunk fiber to increase the density and increase the distance.

This paper will look at multiple solutions for the Remote PON Termination Device and compare them based on cost, efficiency, reliability, and network performance.

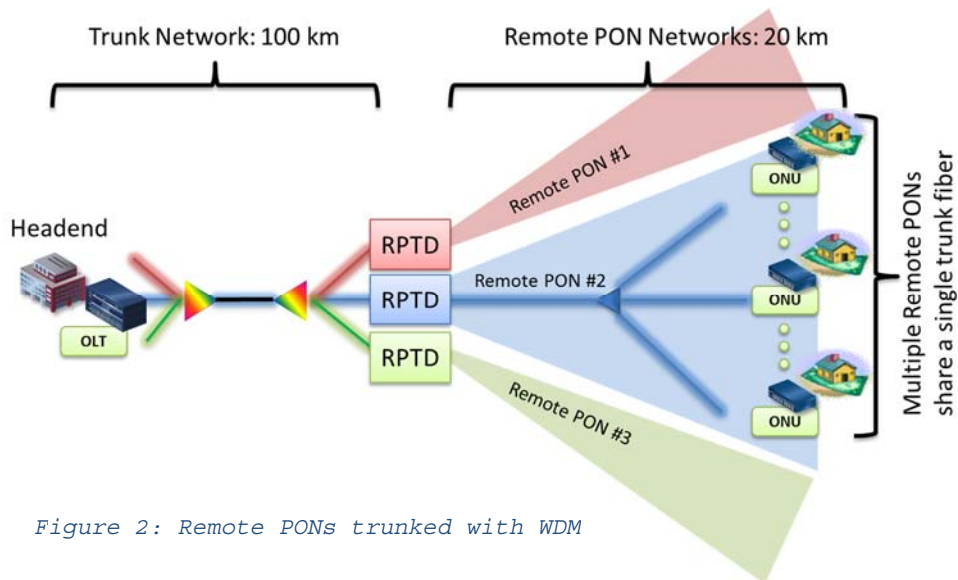

Figure 2: Remote PONs trunked with WDM

Figure 2 shows a typical application of the RPTD to service 3 distant Remote PON networks using 3 WDM wavelengths.

This paper will look at 3 topologies for backhauling the Remote PON networks. The three topologies are needed to support long distance, high density, or high bandwidth requirements.

Topology 1: PON-to-PON

A headend located PON can be used to feed a number of remote PON networks. This

solution provides a very high density aggregation of subscribers. A 1:32 split ratio Trunk PON could support 32 1:32 Remote PONs. A single fiber from the hub site could support 1024 customers (32x32) in this configuration. If 1:64 split ratios could be supported on the Trunk PON or Remote PON, the subscriber count could be up to 2048 or 4096 customers from a single headend fiber.

Since this solution uses PON optics and supports 32 or 64 devices, it is lower cost and uses fewer fibers than the WDM Trunk

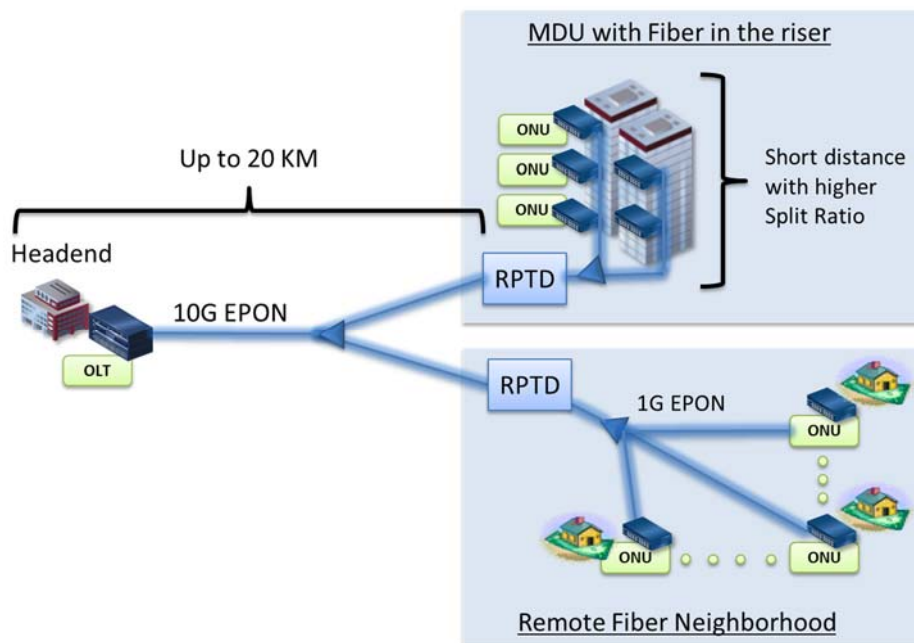

Figure 3: PON-to-PON Application

topologies. Of course, the WDM uplink topologies provide significantly more bandwidth.

The PON-to-PON topology could be a very cost effective solution for connecting MDUs with fiber to each apartment. A Remote PON terminating in the basement or outside the MDU would have shorter reach requirements so a 1:32 trunk to 1:64 remote PONs is possible. The operator could connect multiple buildings or MDU complexes to the trunk fiber and significantly reduce the number of fibers needed to service the subscribers.

The PON-to-PON could be used to aggregate multiple lower speed PON neighborhoods to a higher speed trunk PON. Low cost 1G ONUs would be used in the home while higher bandwidth 10G EPON is used in the trunk network.

In addition to the bandwidth limitations, the PON to PON topology has distance limitations compared to the WDM trunk topologies. Each

solutions and less likely for long reach applications.

Topology 2: WDM-to- Single PON

Point-to-Point CWDM or DWDM optics can be used to provide a long reach and multiplexed trunk fiber to a Remote PON network. A pair of wavelengths for every PON would be appropriate when the distribution of the subscribers is beyond the reach of a Trunk PON or there is a need for more bandwidth to the Remote PON networks. The cost in the Trunk is increased due to the pair of WDM optics and OLT port required for each Remote PON network. While the PON-to-PON shares a 10G EPON uplink for a set of Remote PONs, the WDM-to-Single PON provides an 10Gbps uplink to each Remote PON. With high power WDM optics, it is possible to reach distances of 100 km. A single port device has the potential to be small and located close the subscribers so a larger split ratio (64 or greater) maybe possible.

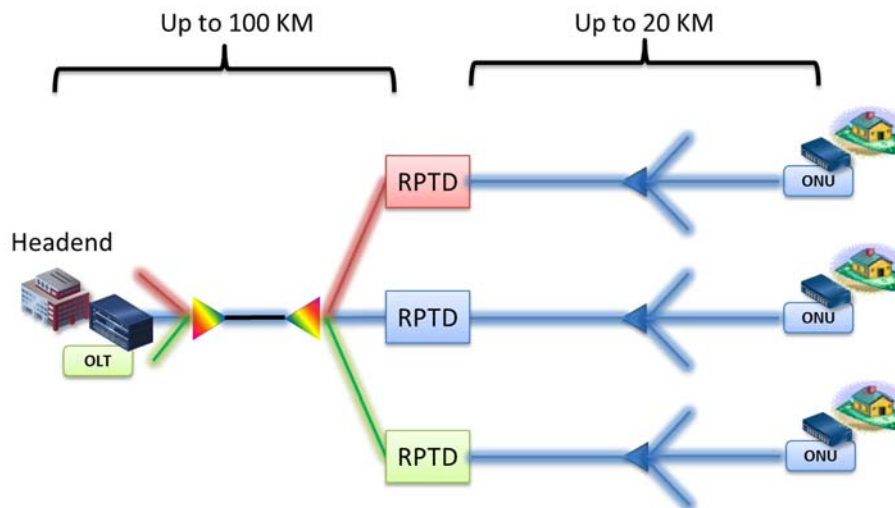

Figure 4: WDM-to-Single REMOTE PON

PON is limited to 20km so the maximum reach of this solution is 40km if both PONs are at their full reaches. Because of the bandwidth distance limitation, a PON-to-PON topology would be more common used for high density

Topology 3: WDM-to-Multiple PONs

In many situations, the MSO will need to connect more than 32 or 64 subscribers at a remote location. In this case, a device that supports more than a single PON off of a single

wavelength pair would be beneficial. By supporting 2 to 8 PONs off a RPTD, an operator can significantly reduce the power, space, and cost of a single WDM wavelength and OLT port per Remote PON. The uplink from the RPTD could have one or more 10G Ethernet links or a higher speed 40G/100G Ethernet trunk connection.

The aggregation of Remote PONs onto higher speed or fewer Trunk links allows an operator to conserve the Trunk fiber and reduce the cost. The ideal solution would allow the operator to start with a single uplink and flexibly add uplink bandwidth from the RPTD to respond to higher customer take rate or higher bandwidth demands.

This type of solution can be used at a new housing community outside the reach of the Headend site. In some cases, a MSO may choose this type solution to reduce the space or eliminate equipment in small remote hubsites.

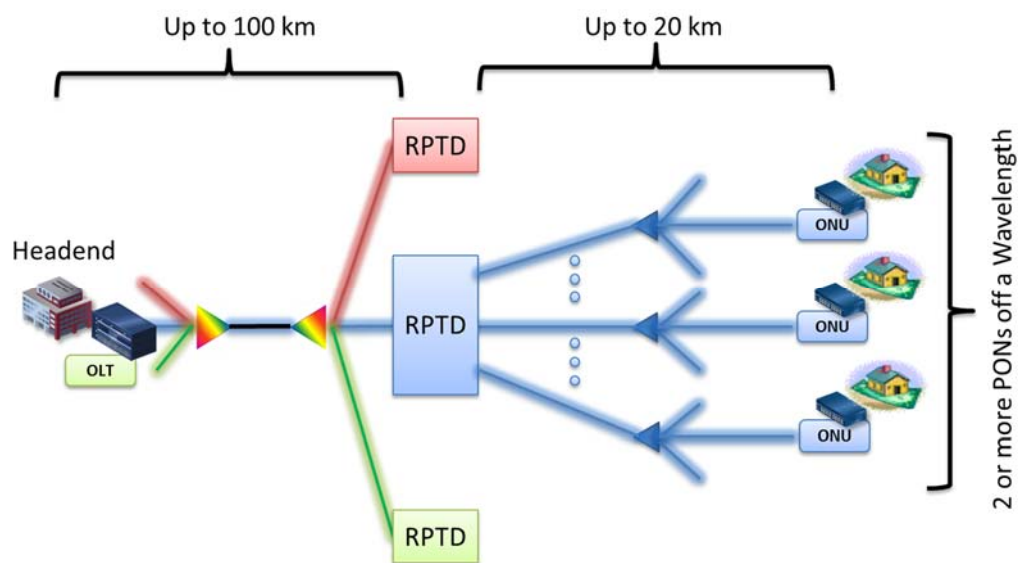

Figure 5: WDM to Multiple PONs

SOLUTIONS FOR THE REMOTE PON TERMINATION DEVICE

PON Repeater (PON Extender)

A PON Repeater or PON Extender is a physical layer device designed to use a single PON MAC layer across fiber networks. The purpose of the Repeater is to extend the distance beyond the typical 20Km reach and to conserve fiber on the trunk side. In general there have been two different basic approaches for PON Repeaters: OEO and packet repeater.

supports coexistence of different PON rates on the same port. The Repeater also does not allow data rates on the trunk side to be converted to a different rate on the remote side since it is intended to be a pass through device.

An alternative to the strict OEO layer 1 approach is to implement using a packet repeater where the entire PON packet is recovered and then a copy of the packet is regenerated. This approach is more complicated as the entire packet has to be received and regenerated. This approach can add delays

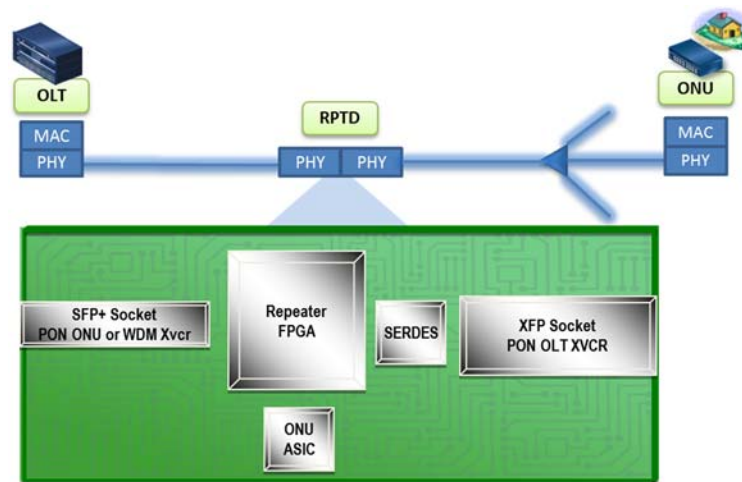

Figure 6: Anatomy of Repeater/PON Extender based RPTD

The OEO approach is a layer 1 device which converts optical signals into the electrical domain for amplification and then converts back to the optical domain at a different wavelength. While the downstream signal is easy to implement with this approach due to the fact that it is a continuous transmission, the bursted upstream is more problematic to implement since information from the MAC to identify slot boundaries is not available. In addition, supporting coexistence of different PON rates such as 1Gbps and 10Gbps poses another challenge. The OEO needs to properly discern the length of upstream burst and prevent false detection. On the trunk side, the bursted upstreams are combined into a continuous signal. To date there has not been a commercially available OEO Repeater that

that pose potential issues with violating the PON delay and jitter requirements. With either of these approaches because the PON MAC is not terminated in the extender, the OLT DBA has to be tweaked to allow for the longer distances. MSOs need to work with the OLT provider to enable these functions as they are beyond the PON specifications. MSOs also need to be aware of upstream performance issues due to extended grant times for upstream transmissions. To minimize this performance impact, OLT vendors will need to make further changes to the DBA which can be a time consuming and costly endeavor.

Controlling the clock jitter and wander is another challenge with the Repeater solutions. Since EPON is loop-timed, the clock frequency of the all downstream and upstream signals in

and out of the Repeater must match the OLT downstream. The jitter and wander added by a long fiber on the trunk network can cause a violation to the tight jitter and wander requirements of the Remote PON network.

Figure 6 shows a block diagram of a possible PON Repeater solution. While some PON Repeaters only support Point-to-Point transceivers on the trunk side, this paper assumes that the PON Repeater can support either PON or Point-to-Point WDM transceivers on the trunk side. On the PON side, a burst SERDES and PON OLT transceiver are required. PON Repeaters often contain an ONU ASIC so the device can register with the OLT and provide some management capability. The functionality in the FPGA is based on the amount of PON physical layer included. An OEO device will have a smaller and simpler FPGA than a packet repeater that includes the Forward Error Correction and line decoding functions. In all cases, the FPGA must have a fixed delay through it, pass clocking, and provide a multiplexor path for the ONU ASIC to the Trunk network.

Remote OLT

Figure 7 shows a block diagram of a Remote OLT. The central office shelf has been shifted to the location of the Remote PON. The OLT MAC Layer, traffic management, switching, subscriber management, and other functions require a significant number of large ASICs and memories for a 10G PON system. The Headend equipment is significantly simplified to an Ethernet aggregation switch for the topologies with WDM on the trunk network.

The Remote OLT can overcome the performance and distance issues of the Repeater. However, creating a smaller and hardened OLT for the outside plant is a significant challenge. There are several challenges for putting an OLT in a node. The node has limited power, space, and is environmentally challenging. Many of the components in a headend OLT are not designed for industrial (-40° to 100° C) or extended (-40° to 120° C) temperature range as forced air cooling is readily available and the expected temperature are much lower in the headend. Higher temperature components can increase the cost and limit the choices of

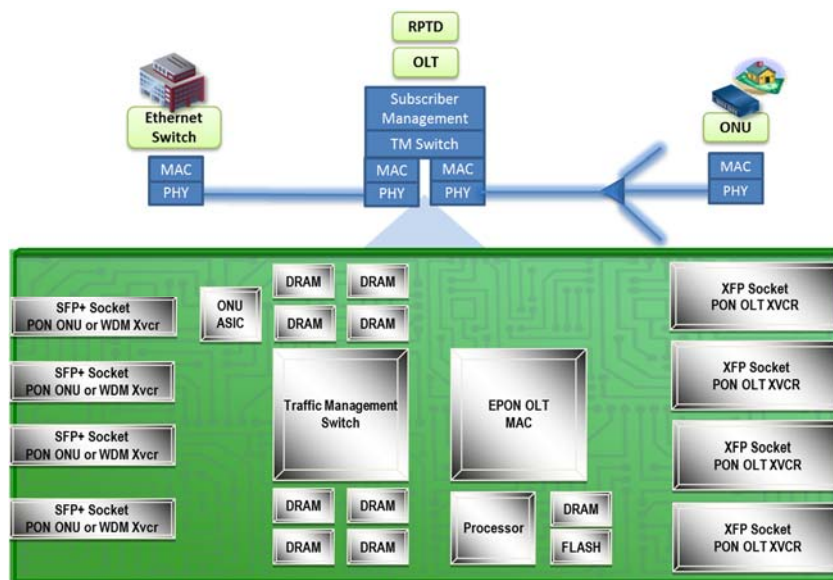

Figure 7: Anatomy of Remote OLT based RPTD

components. Even a scaled down OLT with just a handful of PON ports will have much higher power requirements than a Repeater. A typical node provides up to 140W of power and an OLT could consume most or all of the electrical power budget due to having the full functionality of OLT in the node. Space is also a precious resource inside a node housing especially one that is also hosting a traditional HFC node.

Even with the challenges noted, a Remote OLT has several important advantages. Due to the PON having to work with shorter loop distances, higher splits can be supported with low cost optics. The Remote OLT can improve IP layer performance as DBA can be tweaked to improve polling and the OLT can aggregate PON bandwidth into the trunk side.



Figure 8: Legacy OLT Functions

Distributed OLT

The Remote OLT’s significant performance improvement is desirable but the power, space, and cost of the solution makes it impractical. The third option is a Distributed OLT Architecture. To describe this option it is necessary to understand the anatomy of a common OLT. An OLT is made up of the following functions: optical engine (including both forward lasers and return receivers), Media Access Control (MAC, enforcing synchronicity and end point access policies to the shared PON medium), layer 2 switch fabric (providing up and down link connectivity to

the outside world, dissecting and combining data streams to and from multiple MAC endpoints), and management software (providing policy guidance for provisioning, control, and monitoring of the PON system). See Figure 8.

In a Distributed OLT each function of the OLT can be considered independently to address the needs of a particular topology or service mapping. Considering functions separately allows a network to be built and scaled around their natural strengths. See Figure 9. The optics have been considered separately in small form factor pluggables, so that is not new. The MAC, layer 2 switch, and controlling software on the other hand have been considered one box, with no visibility to their innate flexibilities.

The MAC for instance in the effort of creating an efficient box, which services as many PON ports as possible, would span many service groups at a time, which is not ideal for very granular applications of PON. The layer two switch embedded into a box leverages the low cost and flexibility of what is now a commodity part in a very competitive market. The control and management mechanism can reside either locally or remotely allowing flexibility of operations alongside parallel services that might be present.



Figure 9: Modularized Functions of the OLT

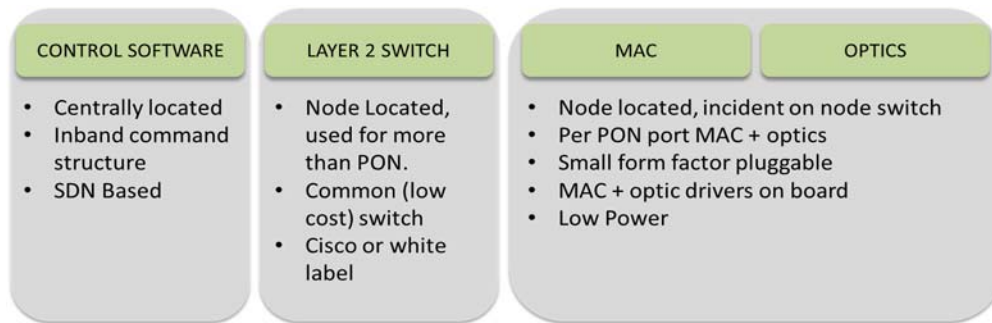

Figure 10: Distributed OLT, MAC and Optics Integration of OLT

For the cable space, which could favor a granular approach to PON deployments, one application of OLT modules is the combination of the MAC function and the optical engine. Allowing a one to one correspondence between a PON and its optical and MAC service. See Figure 9. In particular when taking into consideration the ubiquitous nature of the HFC node and the evolution towards nodes as platforms hosting various services beyond HFC it makes sense to have a PON option that can scale per-PON-port in the presence of layer two switching which might already be present due to other applications running through a node.

One notable item in the OLT structure (see Figure 10) is a centrally located PON software suite. This control module is no longer bound to the location of the OLT box, but can instead be a logical abstraction of the OLT at a central location. On one hand this fits particularly well in an evolution to an SDN based application of PON services. This approach needs a robust communication mechanism between the central command location and the remote switch and OLT.

It is then conceivable that a PON application specifically tailored for cable is just another orchestrated service, using Ethernet transmission and tagging, alongside the other services offered through the HFC node. These services can be applied via the insertion of a pluggable optic and MAC. This allows new PONs to be created as needed.

Distributed OLT Solution

The breakdown of the OLT allows for a smaller solution in the outside plant and a higher density solution with more functionality in the Headend. Figure 11 shows the anatomy of the solution using off-the-shelf PON components. The shelf processor, traffic management, and subscriber management has been removed from the Remote OLT to significantly reduce the size and power requirements.

DOCSIS Provisioning over EPON (DPoE) introduces the concept of “Virtual Cable Modems” for the management of ONUs. The ONUs in a DPoE system are simple devices with only layer 2 management. The DPoE software in the headend translates layer 3 management to a simpler layer 2 management for the ONU. This layer of simplification allows low cost ONUs used in the rest of world to work with a DOCSIS based backoffice similar to a Cable Modem. For a Distributed OLT, a “Virtual OLT” can be imagined to simplify the OLT requirements of the RPTD. The RPTD can be managed by layer 2 OAM and the majority of the OAM to ONUs can be passed through from the Headend to the ONU. Just like the messaging from the DPoE virtual cable modem to the ONU, a cable industry specification for the layer 2 OAM from the DPoE system virtual OLT to the OLT MAC in

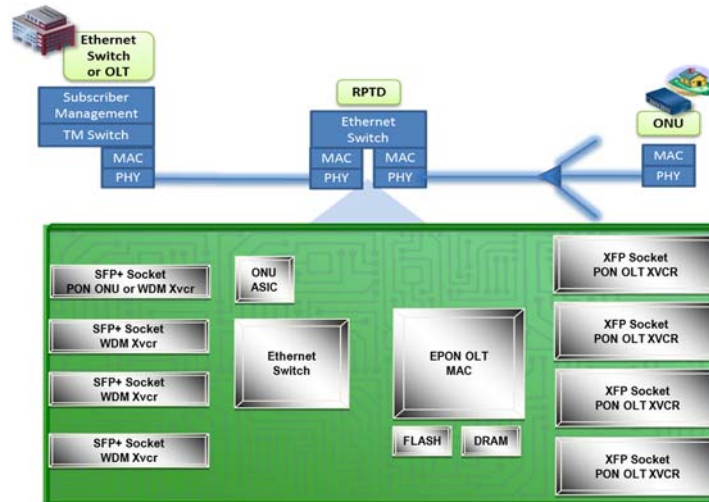

Figure 11: Anatomy of Distributed OLT based RPTD (fixed board)

RPTD would allow for interoperability and a clear definition of the required functionality.

To simplify the switching requirements, the downstream traffic could be shaped and switched in VLANs for transport to the RPTD. The RPTD will not require buffering for shaping or complex switching decisions. A VLAN tag is removed and mapped to the downstream LLID. There is no need to pass the downstream SLA or switching rules to the RPTD. In the upstream direction, the Dynamic Bandwidth Allocation needs to be configured with the upstream SLA. The switching rules are passed directly to the ONU for the mapping of user traffic to the Logical Links (LLIDs). The RPTD can shape the upstream traffic based on the DBA and add a VLAN tag based on the upstream LLID. In the upstream, the SLA and LLID to VLAN mapping will be configured from OAM.

In the headend, the traffic management, switching, and subscriber management can be centralized in a system supporting many remote or local PON networks. The centralization and abstraction of these functions allows for greater flexibility, lower cost, and easy upgradeability. It would be much more difficult to upgrade or modify these functions if they were located in the outside plant RPTD. In addition, the cost is higher and

reliability is lower for functions hosted in the outside plant. For this reason, all functions that can be virtualized or hosted in the headend should be done there. The functions in the RPTD should be limited to the translation of VLANs to PON links.

Looking forward, it is conceivable that a headend box could support remote access for point-to-point Ethernet, PON, wireless, DOCSIS, or other access technologies. It is also conceivable that this function could be in the cloud and further from the edge of the network. The management of the OLT MAC can be done in a management VLAN through many hops of Ethernet switches. A new shelf is not required to realize the Distributed OLT in the short term. An OLT shelf today could be designed with a blade of point-to-point Ethernet ports that either bypasses the PON OLT MAC or is designed without it. The OLT shelf or DPoE software would need modification to send the new virtual OLT OAM messages.

The Modular Distributed OLT

Since the Distributed OLT allows for a simplified interface from point-to-point Ethernet to Ethernet PON, it is possible to imagine a more densely integrated solution

with even greater flexibility. In the Modular Distributed OLT, the EPON OLT MAC function is simplified to a single channel and integrated into a pluggable module. The industry has already seen the integration of the EPON ONU MAC and GPON ONU MAC functions into SFP optics modules so it is reasonable to assume that the same integration would be possible with a simplified OLT MAC function. Ideally, the form factor of this pluggable would be SFP+ so it is interchangeable with the WDM Optics modules but other form factors such as XFP and QSFP could be beneficial as well.

single WDM uplink and a single PON in addition to other configurations with many PONs and uplinks.

This approach has the benefits of the Remote OLT while not encumbering the solution with all the challenges of placing the full set of OLT functions in the node. Keeping the lower layer MAC with the optics in the node preserves the timing and optical link budget for the local loop while lowering the power and space impact of the upper layers (traffic management functions, device management and IP). The use of VLAN between the node and headend OLT preserves the function that each side of the

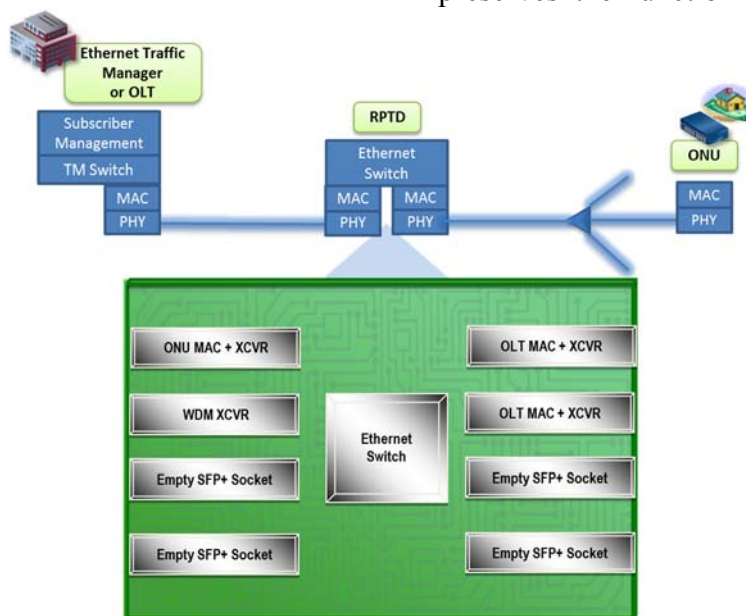

Figure 12: Anatomy of a Modular Distributed OLT based RPTD

The simplification of the PON OLT and ONU functions to pluggable modules allows a simple Ethernet Switch to become the only fixed onboard device for an RPTD. This allows for a low initial install cost and significant flexibility on the number of Remote PONs and uplink Trunks. The 8 port switch in Figure 12 could have any number of Remote PON OLT modules or WDM uplink modules until all 8 ports are filled.

The majority of the cost is in pluggable WDM or PON modules so it scales with the bandwidth and subscriber count. The 8 port switch shown will be cost effective with a

distributed architecture performs while allowing the other end to independently function. For example, downstream traffic management can be done in the headend while still allowing the MAC to distribute the data on the appropriate flow to the ONU.

Having the more complex functions in the headend also allows better scaling of those components across multiple remote nodes. In the future, improved efficiencies via next generation silicon and/or alternative architectures such as network virtualization can be done in the headend while the

components in the node remain the same. This allows operators to leverage next gen technologies without the associated high touch upgrades in the node.

PERFORMANCE ANALYSIS

Systems for Analysis

The Remote OLT, Distributed OLT, and Modular Distributed are fundamentally the same for performance analysis. They move the EPON MAC Layer and EPON PHY Layer closer to the Remote PON. For simplicity, the analysis will refer to these flavors of RPTD solutions as the Distributed solution. Clearly the Remote OLT is not a Distributed solution but it will have the same data plane performance for delay, jitter, and efficiency since the location of the management, shaping, and switching doesn't change the performance on the PON network.

The EO Repeater and Packet Repeater solutions will have a small delay difference in the upstream. The Packet Repeater will have additional delay for the maximum size of a 1 Gbps burst slot. The Packet Repeater will also add additional inefficiencies in certain configurations. A detailed analysis of the Packet Repeater is beyond the scope of this paper. To simplify the analysis, both the EO Repeater and Packet Repeater will be the Repeater solution. It should be noted that the numbers correspond to the EO Repeater and the best case for Packet Repeaterand.

DBA Modifications

Many papers have been written on modifications to the Dynamic Bandwidth Allocation (DBA) algorithms of the OLT as a way to mitigate the performance impacts of longer reach and higher density PON networks. Some have suggested predictive algorithms for granting. While this method may decrease delay, it can dramatically decrease the efficiency. Other suggestions such as a Multi-

Thread DBA [3] are generally good ideas for improving the performance and the delay in the PON upstream.

Modifications to the DBA algorithm are not considered here. The delay and efficiency issues explored in this paper are fundamental (i.e. minimum delay, MAC round trip time, efficiency of many bursts) to expanding the PON MAC over higher density or longer reach networks. The DBA for the system is a request and grant, weighted round robin, and assumes multi-threading (i.e. multiple grants in flight).

PON-to-PON High Density Deployment

The PON to PON topology can be cost effective for aggregating high density networks. While it allows for extending the reach from 20 km to 40 km, it is not expected to be used for the longer reach due to the distance limitation of 40 km. The PON to PON network is a low cost solution for aggregating many subscribers from MDUs or neighborhoods when trunk fiber is limited.

In some situations, it will make sense to connect multiple 1G EPONs to a single 10G Trunk EPON as a cost effective aggregation scheme. Since the Repeater is a physical layer construct, it is not possible to connect multiple 1G EPONs to a 10G EPON through a Repeater. 10G EPON has a different frame format for Encryption and Discovery so a single data rate conversion isn't possible. The Distributed model can support 10G to 1G EPON connection since the MAC layers are terminated.

Since both solutions can support 10G EPON Trunk PON and 10G EPON Remote PON, the analysis will be focused on this solution. The biggest difference between the Distributed and Repeater solution is the isolation of the PON overhead. In a Repeater Solution, all of the Remote PONs and the Trunk act as a single PON. The OLT at the trunk will need to request and grant to all of the ONUs and their Logical Links (LLIDs). The amount of PON

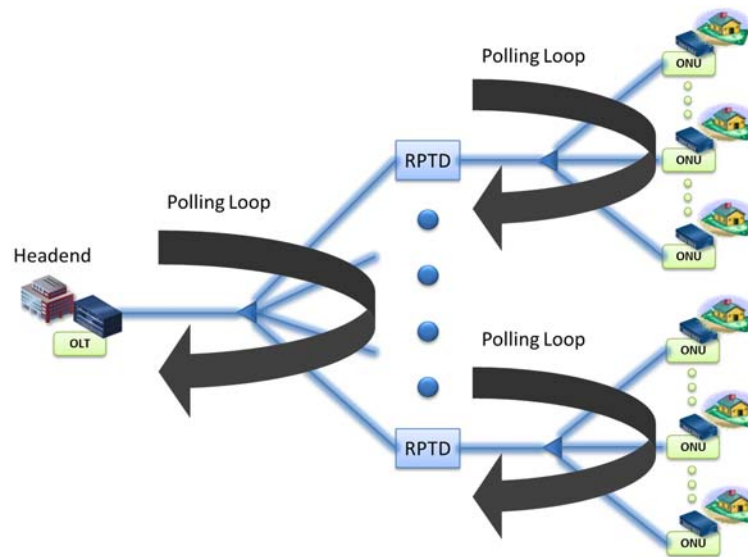

Figure 13: Parallel Polling in the Distributed Solution

overhead for requesting, granting, and burst overhead multiplies by the number of Remote PONs.

In the case of the Distributed Solution, the OLT at the trunk will request and grant to each of the Remote PON Termination Devices which in parallel will request and grant to their ONUs. The PON overhead is isolated to the PONs and doesn't increase as the number of Remote PONs increases.

Figure 13 shows how the polling (grant to report queue status) is isolated and performed in parallel for the Trunk and Remote PON networks in the Distributed Solution.

The isolation of the Remote PON networks significantly reduces all of the overhead for the PON.

The upstream burst overhead of 10G EPON is described in [2]. The upstream overhead for 128 ONUs or LLIDs is taken as a reference. A PON with 32 ONUs and 4 LLIDs each will act like 128 single LLID ONUs. For comparison, a 2ms DBA cycle time will be considered. With the Repeater solution, the upstream burst overhead increases with the number of Remote PONs. Table 1 shows the calculation of the overhead and bandwidth based on the size of the PON MAC domain.

Remote PONs	1	2	4	8	16	32
ONUs per Remote PON	32	32	32	32	32	32
Total ONUs	32	64	128	256	512	1024
LLIDs per ONUs	4	4	4	4	4	4
Cycle Time (ms)	2	2	2	2	2	2
FEC Encoding Overhead (%)	12.38	11.87	10.85	8.81	4.73	0
Codeword Quantization Overhead (%)	0.54	1.08	2.16	4.32	8.64	17.28
Time-Quantum Rounding Overhead (%)	0.09	0.18	0.36	0.72	1.44	2.88
Idle Prefix Overhead (%)	0.08	0.16	0.32	0.64	1.28	2.56
Burst Mode Transmission (%)	3.48	6.96	13.92	27.84	55.68	111.36
Guard Band Overhead (%)	0.51	1.02	2.04	4.08	8.16	16.32
Control Overhead (%)	0.43	0.86	1.72	3.44	6.88	13.76
Net Transmission Overhead (%)	17.52	22.14	31.38	49.86	86.82	160.74
Net Throughput (Gbps)	8.248	7.786	6.862	5.014	1.318	0

Table 1: PON Overhead for large PON MAC domains

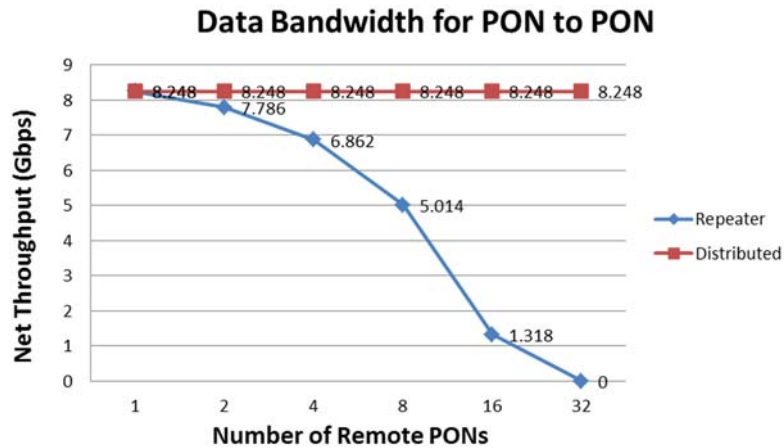

Figure 14: Data Bandwidth for PON-to-PON

With the Distributed Solution, the isolated PONs allow the overhead to be held constant. Figure 14 shows the effect on data throughput based on the number of Remote PONs, each with 32 ONU with 4 LLIDs per ONU.

The upstream burst overhead penalty is significant for the Repeater Solutions. 8 Remote PONs reduces the bandwidth to 5 Gbps and 32 Remote PONs would be consumed by the burst overhead.

The delay and jitter of the network will increase with the number of Remote PONs for both solutions. The PON-to-PON scheme is not the best solution for high bandwidth or low delay/jitter. In the case of the Repeater solution, the single scheduler allows for a low jitter and low delay output. In the case of the Distributed solution, the polling rate or cycle time can be reduced to reduce the delay and jitter.

The requirement of equal speed for the Trunk PON network and the Remote PON network along with the efficiency penalty make the Repeater solution impractical for a high density outside plant aggregation network.

WDM-to-Single PON

The WDM-to-Single PON topology has a single Remote PON with a WDM uplink to the Headend site. The cost of a pair of WDM optics for each Remote PON makes this topology more expensive than a PON-to-PON solution with a single OLT port and ONU optics modules. There is significantly more bandwidth and better delay/jitter in this topology. Since there is a single Remote PON for both Distributed and Repeater solutions, the efficiency is the same.

The biggest difference between the distributed PON solution and the PON repeater when using WDM to a single Remote PON is the upstream delay. In the distributed solution, the EPON upstream control frames are confined to the PON fiber network. In the repeater solution, the PON protocol frames must travel across the PON and the trunk fiber networks. Since the trunk fiber is a majority of the propagation delay, this has a significant impact to the EPON MAC and upstream delay. Figure 15 illustrates the difference between the two solutions.

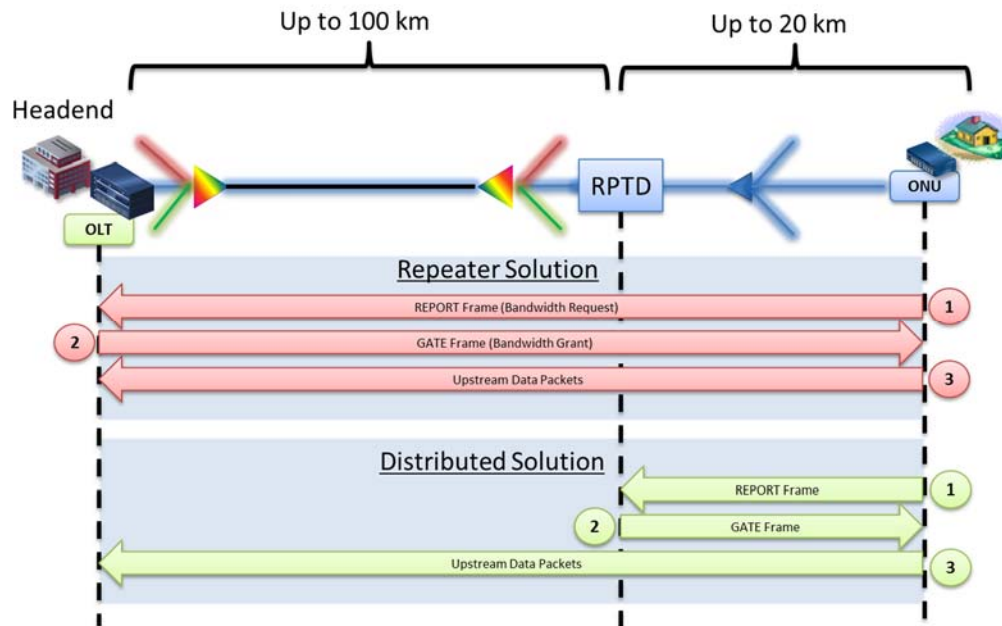

Figure 15: Upstream Data Flow in WDM to Single PON Topology

When an upstream frame arrives at an ONU, a REPORT frame will be sent upstream from the ONU MAC to the OLT MAC. The REPORT contains the bandwidth request for the upstream frame. The OLT MAC responds to the REPORT frame with a GATE granting the ONU an upstream slot for the data. The ONU transmits the data upstream to the OLT. In the Repeater solution, the GATE and REPORT frames must propagate across the trunk network and the PON network. In the case of the Distributed solution, the GATE and REPORT frames are limited to the PON network.

The IEEE 802.3 EPON PON standard is defined for a MAC layer Round Trip Time propagation delay of up to 1 ms. The major portion of the delay is in the fiber network. A 20 km link has a one way propagation delay of 100us so the round trip time is roughly 200us on the fiber. The OLT/ONU MAC and PHY layers normally require 50us. A 20 km EPON OLT MAC would normally see a 250 microsecond round trip propagation time. Since the Repeater solution increases the MAC layer propagation delay dramatically, the IEEE PON standard limit will be reached. At 75 km

of trunk network, the IEEE limit will be reached and the Repeater solution is no longer viable. Since the Repeater will also add delay, a more practical limit is around 60 km. It should be noted that while the standard supports up to 1 millisecond of delay that the OLT devices are not required to support 1ms and many support much less. An OLT device that supports up to 500us would be limited to a limited to 25 km of trunk fiber. Since the distributed solution doesn't extend the MAC layer across the trunk fiber, there is no round trip time impact. The distributed solution can work up to the limits of the trunk fiber transceivers and could go beyond those limits with multiple stages of transceivers.

In addition to the distance limit, the Repeater solution shows has a much greater minimum upstream delay over the Distributed solution. The downstream delay should be very similar or the same on the Repeater or Distributed system. The REPORT and GATE frame going over the trunk effectively triples the transmit delay over the trunk network. The minimum upstream delay for a 10 km Remote PON as a function of the trunk fiber length is shown in .

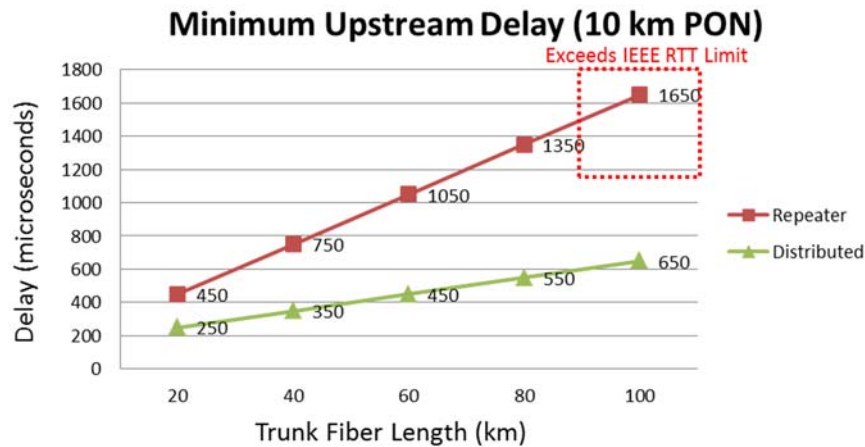

Figure 16: WDM to Single 10km Remote PON Minimum Delay

The Repeater shows a much higher delay over the Distributed solution. The delay for the Repeater is almost triple (650 μ s versus 1.65ms) and 1 ms greater at 100 km. With a 20 km Remote PON, the results (see Figure 17) show a similar difference in upstream delay. Of course, the Repeater is limited in distance by the IEEE round trip of 1ms so the longest trunk fiber distance may not be possible.

The additional delay for the Repeater solution also has an effect on the maximum upstream data rate for the Repeater solution. The EPON ONU must buffer data while it waits for the response from the OLT. In a 10G EPON Since ONUs have a fixed amount of buffer, an increase often results in a drop in

maximum data rate upstream. For example, a 20 km local PON or will require buffer for 250 μ s of OLT response time. In the Repeater with a long trunk fiber, the OLT response time could increase 4 times. The ONU must buffer more data and burst in large blocks to handle the delay. In the case of the Distributed Solution, the delay from the OLT MAC to the ONU MAC is the same as a local PON. There is no need for additional ONU buffering on the Distributed solution.

Figure 18 shows the additional ONU buffer in kilobytes as a function on Trunk fiber length to transmit upstream at the same peak data rate. The Repeater will require an additional megabyte of buffer for an 80 km trunk fiber while the Distributed solution doesn't require any additional buffering to keep the same

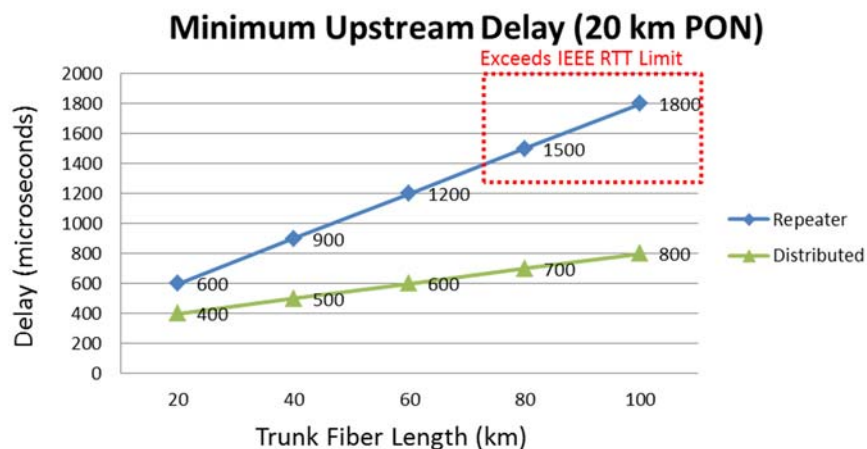

Figure 17: WDM to Single 20km Remote PON Minimum Delay

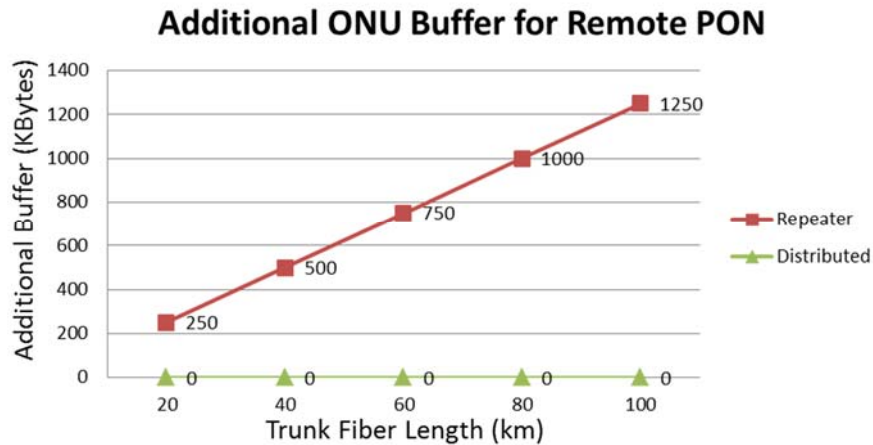

Figure 18: Additional 10G ONU Buffer to support Remote PON

maximum data rate. The buffer size for all upstream LLIDs should be increased to accommodate the additional delay. ONUs on a Repeater based Remote PON should be configured with a larger buffer than those on a Local PON. Of course, the data buffering in an ONU is a significant part of the cost and most ONUs are already configured to use all of the available buffering. If the buffering can't be increased, the maximum data rate will drop. Since most applications do not require the maximum upstream data rate of 8.7Gbps for 10G EPON, many ONUs only have buffer to support a lower maximum data rate for a single ONU.

In Figure 19, the maximum upstream data rate for an ONU is shown as a function of Trunk fiber length. A 4 Gbps maximum rate ONU (or single LLID) and an 8.7 Gbps ONU (or single LLID) are considered in this graph. Since the Distributed Solution doesn't increase the OLT to ONU MAC delay, it doesn't show any change in delay as a function of the trunk fiber length. The Repeater based solution will decrease the maximum upstream burst rate by up to 50% depending on the length of the trunk fiber.

For this reason, ONUs on a Repeater Remote PON will require either a different configuration or will support limited services compared to ONUs on a local PON.

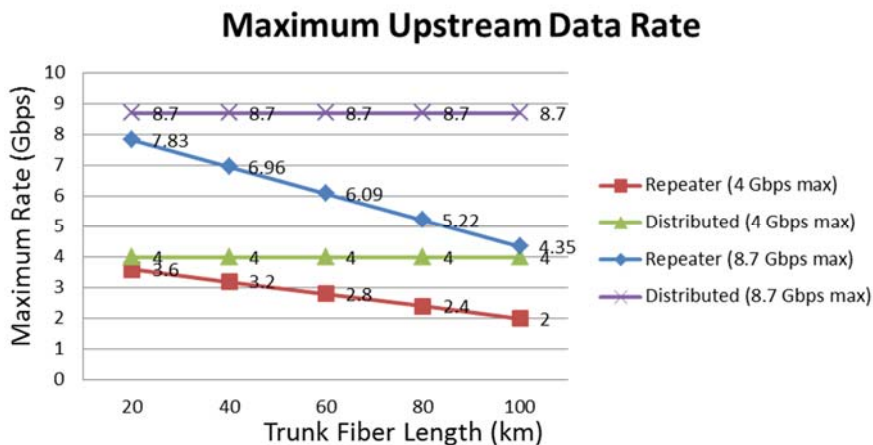

Figure 19: WDM to Single PON Maximum Upstream Data Rate

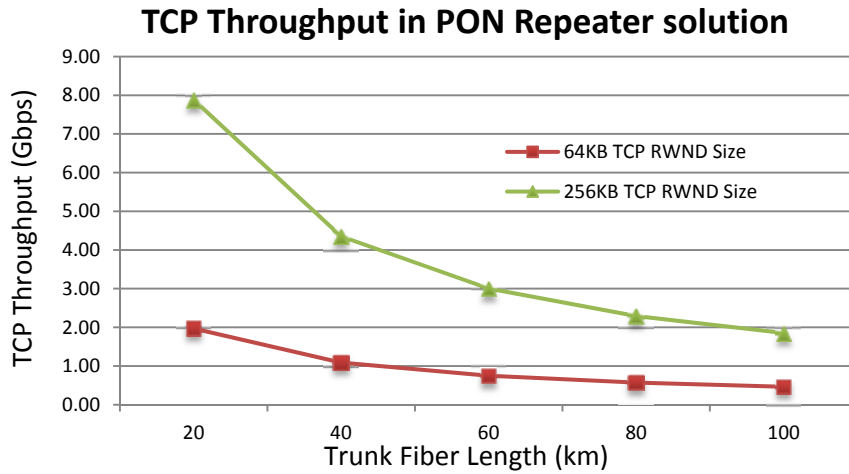

Figure 20: Repeater TCP Throughput Penalty

In the PON repeater architecture, due to the additional propagation delay that is added to the request and grant time, there is an impact to the TCP throughput in the downstream. shows the TCP downstream throughput of an ONU with two different TCP Receive Window sizes – 64k and 256k. As can be noticed from Figure 20, with the 20km trunk fiber distance (ONU to OLT distance), each 10G ONU can receive a theoretical TCP throughput of about 8 Gbps. Clearly with the increase in the trunk fiber distance between the PON repeater and OLT, the TCP throughput degrades from 8 Gbps to sub 2Gbps. The degradation is less dramatic when TCP receive window size is 64k but the overall TCP throughput is lower. TCP stack in older operating systems used to only support 64k receive window size. But most

modern operating systems (Windows 7, 8, Mac OS-X) use window scaling which let TCP use higher than 64k receive window size.

WDM-to-Multiple PON

The WDM to multiple PON architecture allows a single wavelength uplink to connect to multiple PONs. A single Remote PON Termination Device may have multiple WDM uplinks with multiple Remote PONs each. Using a single WDM transceiver to service multiple Remote PONs reduces the cost, power, and size for networks requiring higher density than the WDM-to-Single PON topology.

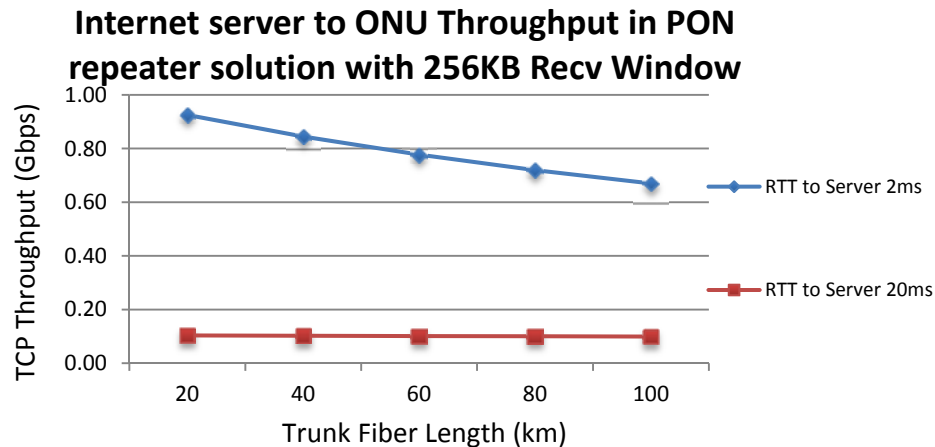

Figure 21: Internet Server to ONU Throughput

In the case of the Repeater, the multiple Remote PONs act as a single PON to the uplink wavelength. The FPGA in the RPTD acts a splitter. This solution increases the number ONU/LLIDs on a single OLT like the PON-to-PON solution. As shown in the PON-to-PON analysis, the combining of multiple PONs on a single MAC severely impacts the data throughput. The WDM-to-Multiple PON topology has the same long reach and MAC delay as the WDM-to-Single PON topology. For the Repeater solution, the WDM-to-Multiple PON has the lower efficiency of the PON-to-PON with the delay/jitter penalty of the WDM-to-Single PON.

In the case of the Distributed Solution, the Remote PON networks are isolated to avoid the upstream overhead penalty. The OLT MAC layer is located at the Remote PON so the ONU buffering, discovery size, and delay is the same as a Local PON Network. There is no need for special ONUs and there is no distance limit for the trunk network.

Figure 22 shows the Distributed Modular RPTD for the WDM-to-Multiple PON. The RPTD is an Ethernet Switch with sockets for OLT, ONU, or WDM transceiver modules. The operator can specify the RPTD by total port count of the Ethernet switch and then choose the number of OLT PON modules or WDM uplink transceivers based on the service requirements. The Remote PON networks will have the same performance as the local PON network plus the one way delay on the trunk fiber. In the upstream direction, the RPTD may see congestion. It is not desirable to have a switch with large external memories that requires configuration of SLAs. To prevent overflow, the switch should provide a priority based flow control or other mechanism to meter the traffic from the modules. There are multiple solutions to this issue but it is beyond the scope of this paper.

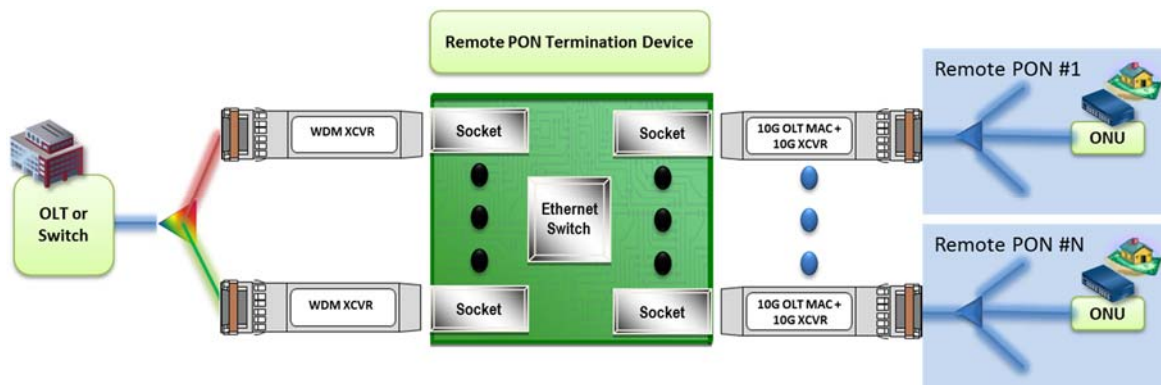

Figure 22: The Modular Distributed OLT solution for WDM-to-Multiple PON

CONCLUSIONS

Remote PONs can be very beneficial to MSOs. They allow the operator to run fiber with very high efficiency or connect customers at very long distances. An operator can reach customers without adding hubsites and could potentially consolidate hubsites. A Remote OLT is not always practical due to the complexity that it places in the node.

We introduced the concept of a Distributed OLT architecture that places the EPON MAC in the outside plant and centralizes the other OLT functions in the Headend. The Modular Distributed OLT provides a more flexible version of the Distributed OLT for the RPTD. Multiple topology choices can provide high bandwidth, low delay, long reach, or high density.

Fundamentally, the Remote PON Termination Device can be designed as a remotely located EPON Physical Layer (e.g. PON Extender, EO Repeater, or Packet Repeater) or an EPON Media Access Control Layer (e.g. Remote OLT, Distributed OLT, or Distributed Modular OLT). The Repeater solutions with the Remote PHY expand the EPON MAC layer over a larger number of users or a much longer distance. The expanded MAC layer in the Repeater solution limits the distance, lowers the efficiency, and significantly increases the delay. The remote MAC Layer solution has the same distance and user count as a Local PON network so it can

use the same ONUs with equivalent performance as a Local PON network.

Table 2 highlights the differences between the possible solutions for the Remote PON Termination Device. Based on these results, it makes sense for the industry to study and standardized a Distributed OLT architecture and Modular Remote PON Termination Device.

REFERENCES

- [1] Glen Kramer, Ethernet Passive Optical Networks, McGraw-Hill, 2005
- [2] Rajesh Roy, Glen Kramer, Marek Hajduczenia, Henrique J. Silva, "Performance of 10G-EPON", IEEE Communications, November 2011
- [3] Bjorn Skubic, Jiajia Chen, Jawwad Ahmed, Biao Chen, Lena Wosinska, Biswanath Mukherjee, "Dynamic Bandwidth Allocation for Long-Reach PON: Overcoming Performance Degradation", IEEE Communications, November 2010

	FPGA PON Repeater (PON Extender)	Remote OLT	Distributed (Modular) OLT
Power	Low	High	Low
Size	Small	Large	Small
Relative Cost	Low	High	Low
Total Reach (Trunk Fiber Limit)	60 Km [or less]	100 Km+	100 Km+
Impacts PON Timing Budget	Yes	No	No
Require Larger ONU Buffer	Yes	No	No
Supports Any Ethernet Speed Uplink	No	No	Yes
Supports High Density of ONUs	No	Yes	Yes

Table 2: RPTD Solution Summary